

7-24-2018

NatSurFact: Progress in commercializing rhamnolipids

Daniel Derr

NatSurFact, USA, dan@natsurfact.com

Follow this and additional works at: <http://dc.engconfintl.org/cosmetic>



Part of the [Engineering Commons](#)

Recommended Citation

Daniel Derr, "NatSurFact: Progress in commercializing rhamnolipids" in "Advances in Cosmetic Formulation Design", ECI Symposium Series, (2018). <http://dc.engconfintl.org/cosmetic/32>

This Abstract and Presentation is brought to you for free and open access by the Proceedings at ECI Digital Archives. It has been accepted for inclusion in Advances in Cosmetic Formulation Design by an authorized administrator of ECI Digital Archives. For more information, please contact franco@bepress.com.



NAT SURFACT[®]

NatSurFact: Progress in Commercializing Rhamnolipids

Advances in Cosmetic Formulation Design

24 July 2018

Dan Derr

858-336-5084

dan@natsurfact.com



Logos is a Technology Developer Focused on the Intersection of the Possible and the Useful

- Logos was founded in the 1990s to develop broad spectrum of technologies – surveillance systems, ground and airborne vehicles, information processing, bio-based chemicals, nuclear energy – for the Department of Defense (DoD). Cultural connections to Lawrence Livermore National Laboratory and Defense Advanced Research Projects Agency (DARPA)
- Won DoD (DARPA) and Department Of Energy (DOE) biofuels-technology contracts – initiated 2005
- Became recognized biofuels innovator
 - More than \$70M in DoD and DOE Projects – demonstration and pilot plant construction
 - Developed biological feedstocks and processes for producing jet fuel for the military
 - Demonstrated mechanical pretreatment in cellulosic ethanol production
 - Developed robust techno-economic modeling approaches for analyzing process' commercial viability
 - Developed high yield fermentation processes (2009 – 2015)
- Selected rhamnolipids for commercialization
- Reorganized BioChem Team to develop rhamnolipids – NatSurFact (2013 – present)
- Laboratory / pilot-plant space in Fairfax, VA capable of producing ~0.5 kg/week

NatSurFact is...

...a mixture of rhamnolipids made from a renewable source – natural vegetable oil. Produced in a natural fermentation process, it is mild when we use it to clean our skin, hair, home, or environment and it does not hurt our ecosphere after use. In all phases of NatSurFact's life, it is environmentally friendly.

We have developed and patented process to make rhamnolipids cost-effectively:

- High (~2 g/L/hr) productivity
- Scaled up 7 times at 2 external partners
- Over 150 samples distributed to 80+ recipients
- Ecommerce for customer engagement

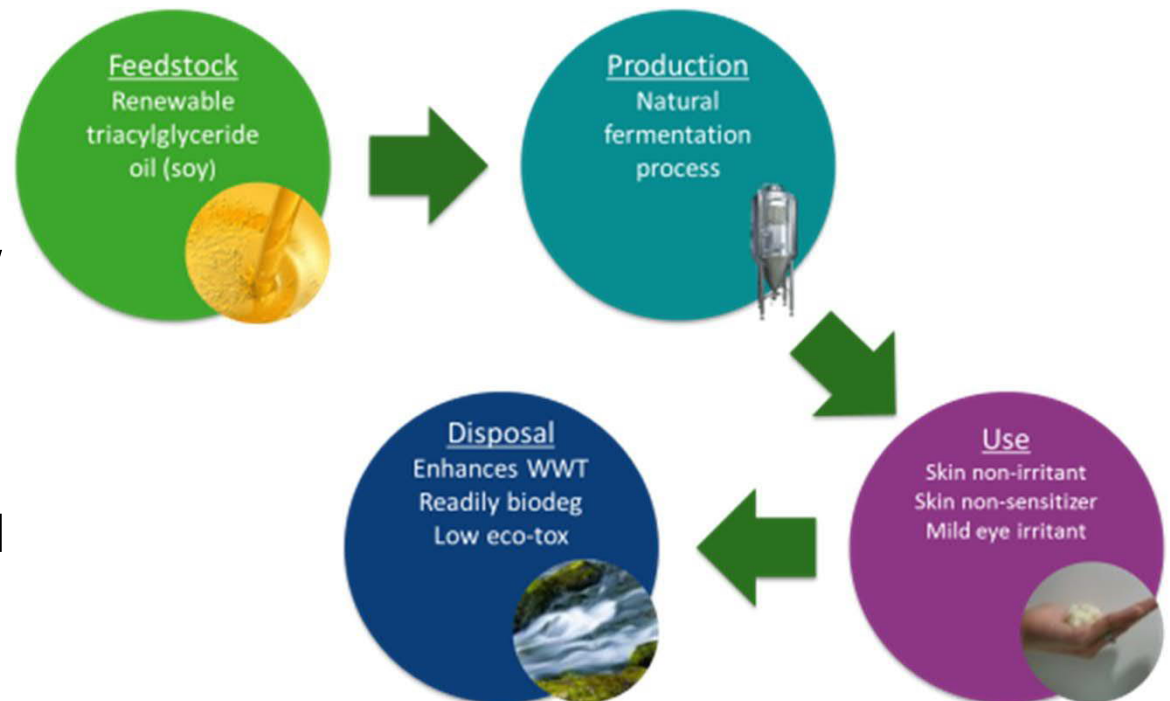

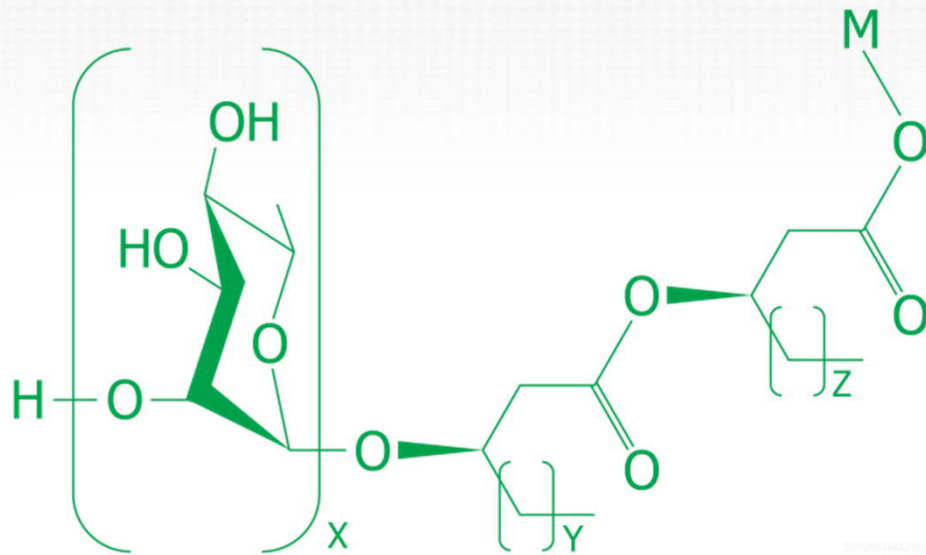

- 1949 – first reported
- Early 1990's – became of substantial academic interest
- Conventional wisdom is that production is too expensive for widespread use

Rhamnolipids are a member of the glycolipid (sugar-fat) family of biosurfactants. Other examples include mannosylerythritol lipids, sophorolipids, trehaloselipids, cellobiose lipids, etc...)

Surfactant component	Dominant make up	Typical variability
Hydrophilic group	Rhamnose sugar	$x = 1$ or 2
Tail	Two 3-hydroxy fatty acids	y and $z = 4, 6,$ or 8 (8–12 carbons), 0 or 1 double bonds

Only made up of C, H, and O – no sulfate or phosphate.
Surfactant form is the salt (M = Na).

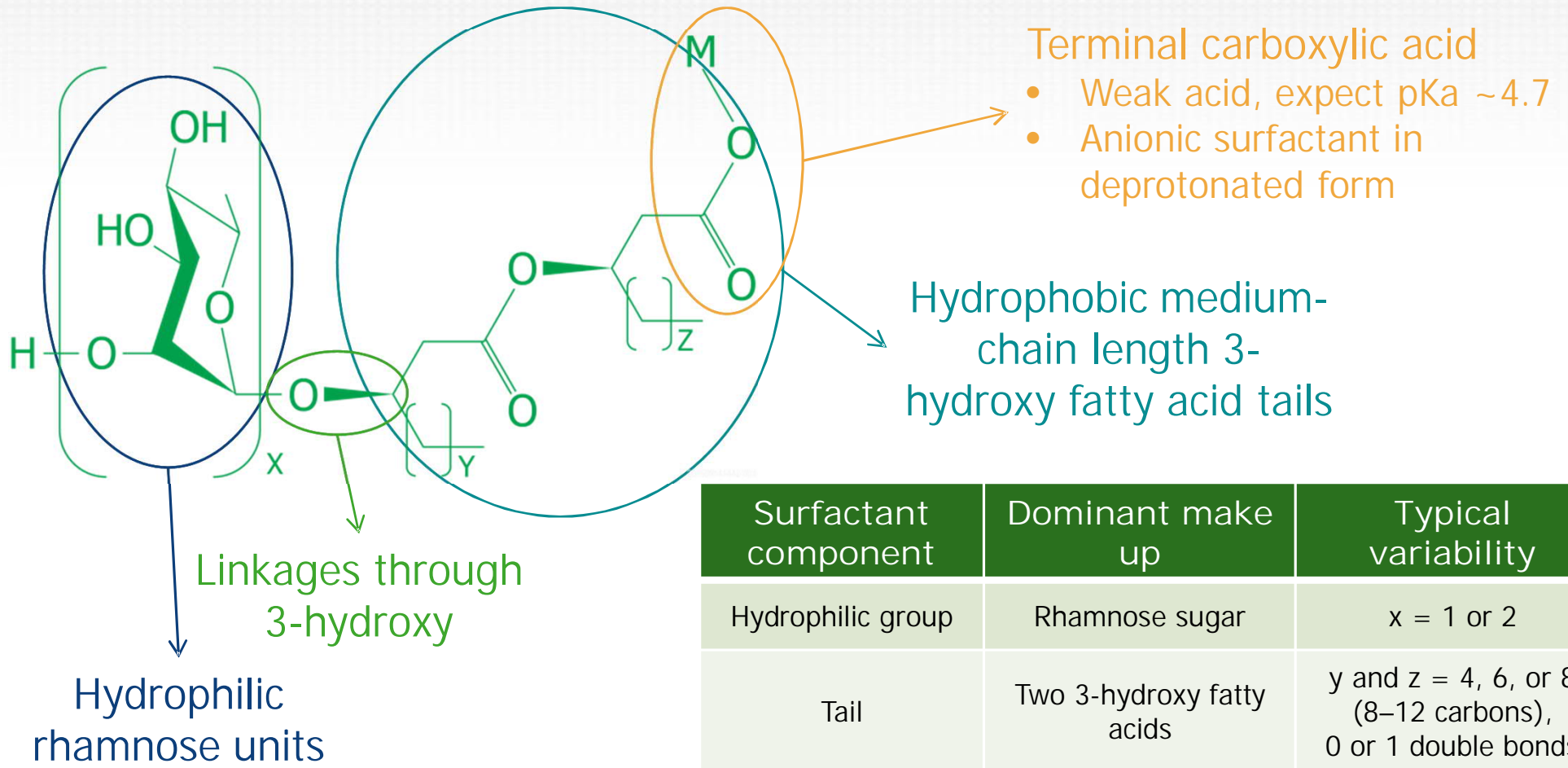

Only made up of C, H, and O – no sulfate or phosphate. Surfactant form is the salt (M = Na).

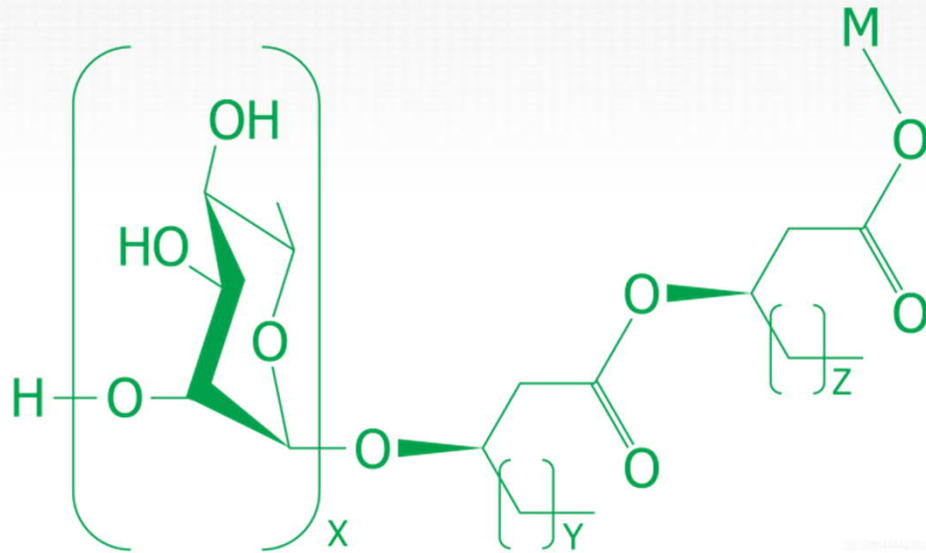

- "Rha-C₁₀-C₁₀" is shorthand for $x = 1, y = z = 6$
- "Rha-Rha-C₁₀-C₁₀" is shorthand for $x = 2, y = z = 6$

- Our organism produces a mix of mono- ($x = 1$) and di-rhamnolipids ($x = 2$)
- Mono:di ratio about 1:1 with C₁₈ rich oils
- In both mono- and di-, most prevalent fatty acid combo is $y = z = 6$

NatSurFact is Mild and Environmentally Friendly

- NatSurFact is mild to humans

- Not a skin irritant
- Not a skin sensitizer
- Only a mild eye irritant



- NatSurFact has low eco-toxicity

- Increases activity of Waste Water Treatment Plant (WWTP) activated sludge
- Readily biodegradable
- Low toxicity to algae
- Low toxicity to freshwater crustacean
- Low toxicity to freshwater fish



- NatSurFact is powerful

- Good foaming
- Low CMC – 50-150 mg/L
- Draves wetting times are typical



NatSurFact is a powerful anionic surfactant

Low CMC

- NatSurFact (NSF) Critical Micelle Concentration (CMC) = 100 mg/L
- Sodium Laurel Sulfate (SDS) CMC = 3 g/L

Good foaming

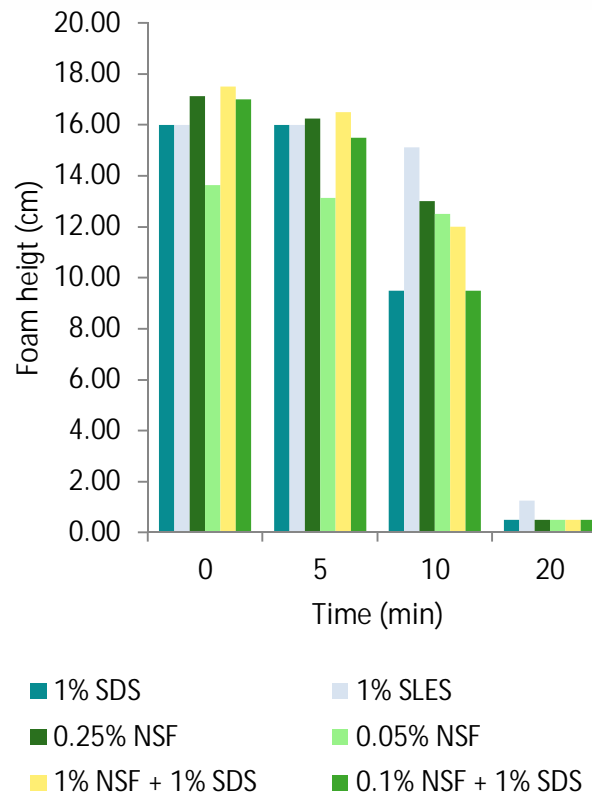

Strong cleansing

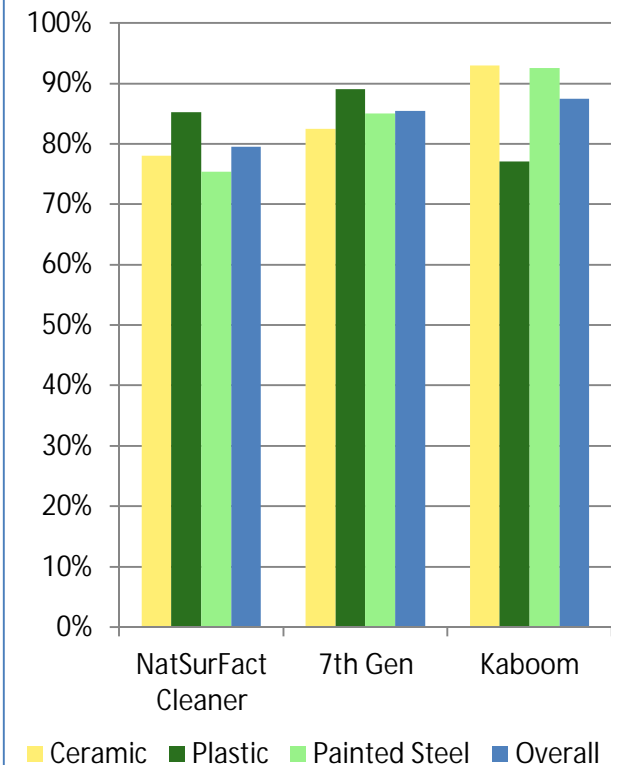

A little NatSurFact goes a long way

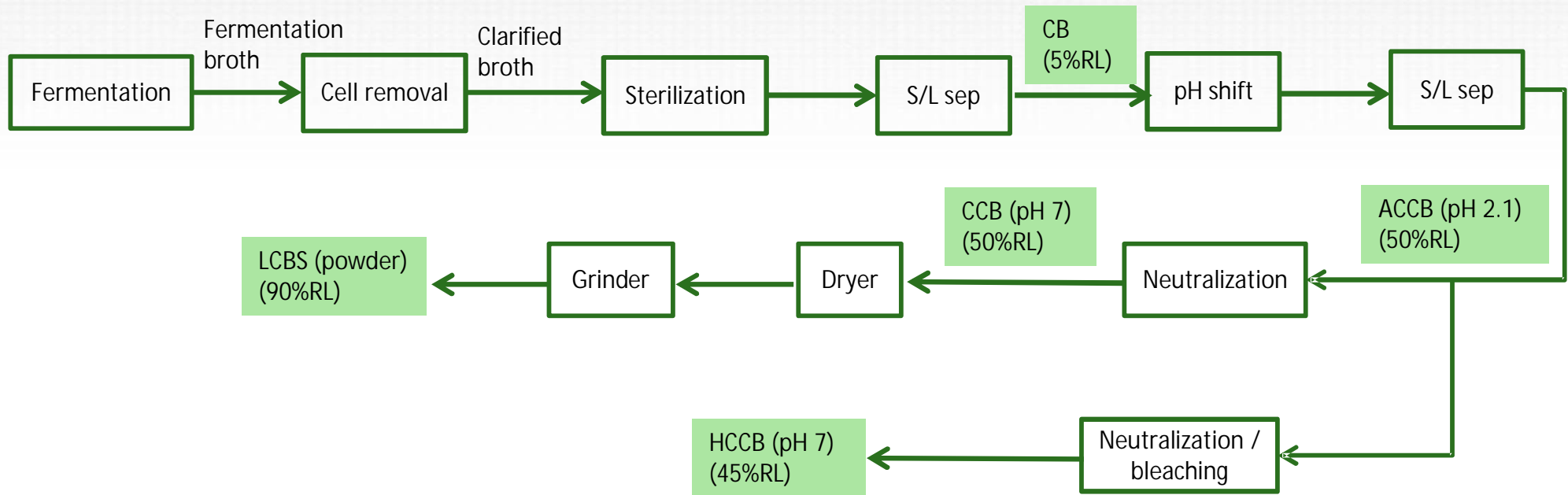

Grade	Description
CB	5% aqueous solution
ACCB	50% water suspension acid form
HCCB	45% aqueous sodium salt form
CCB	50% aqueous sodium salt form
LCBS	90% neat powder sodium salt

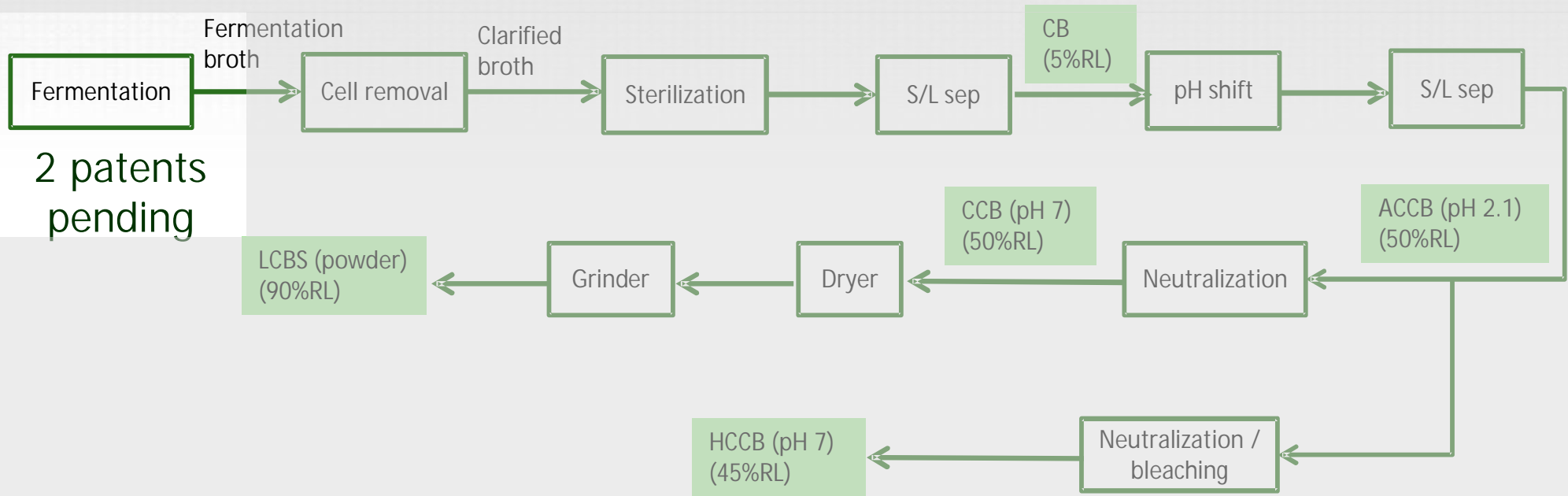

Grade	Description
CB	5% aqueous solution
ACCB	50% water suspension acid form
HCCB	45% aqueous sodium salt form
CCB	50% aqueous sodium salt form
LCBS	90% neat powder sodium salt

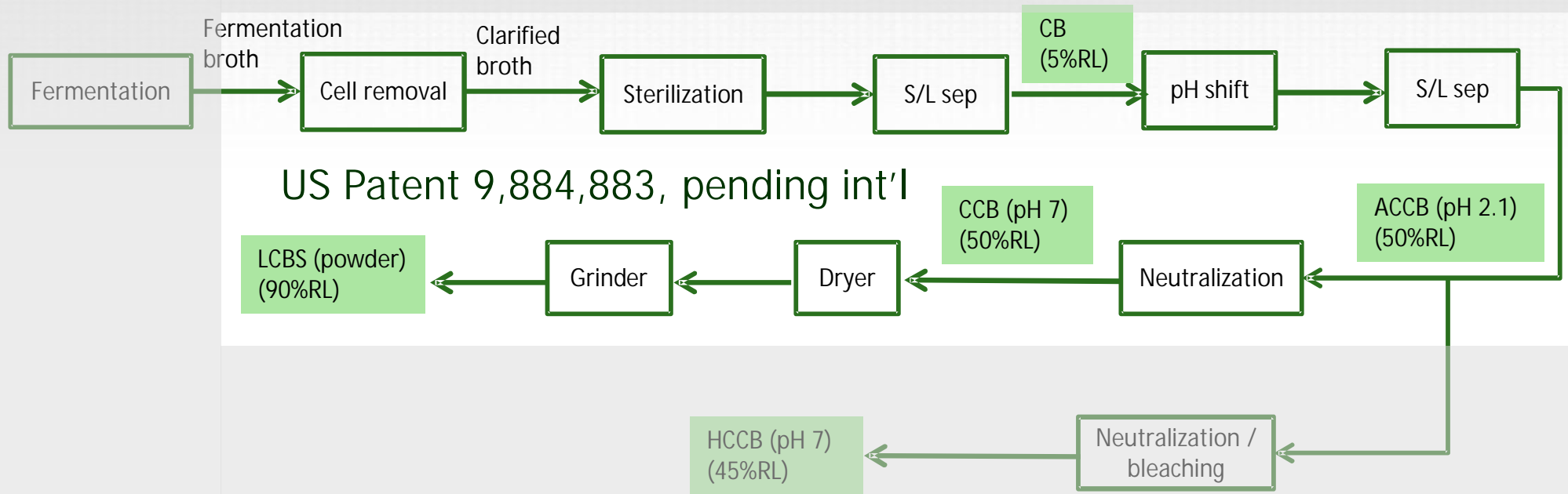

Grade	Description
CB	5% aqueous solution
ACCB	50% water suspension acid form
HCCB	45% aqueous sodium salt form
CCB	50% aqueous sodium salt form
LCBS	90% neat powder sodium salt

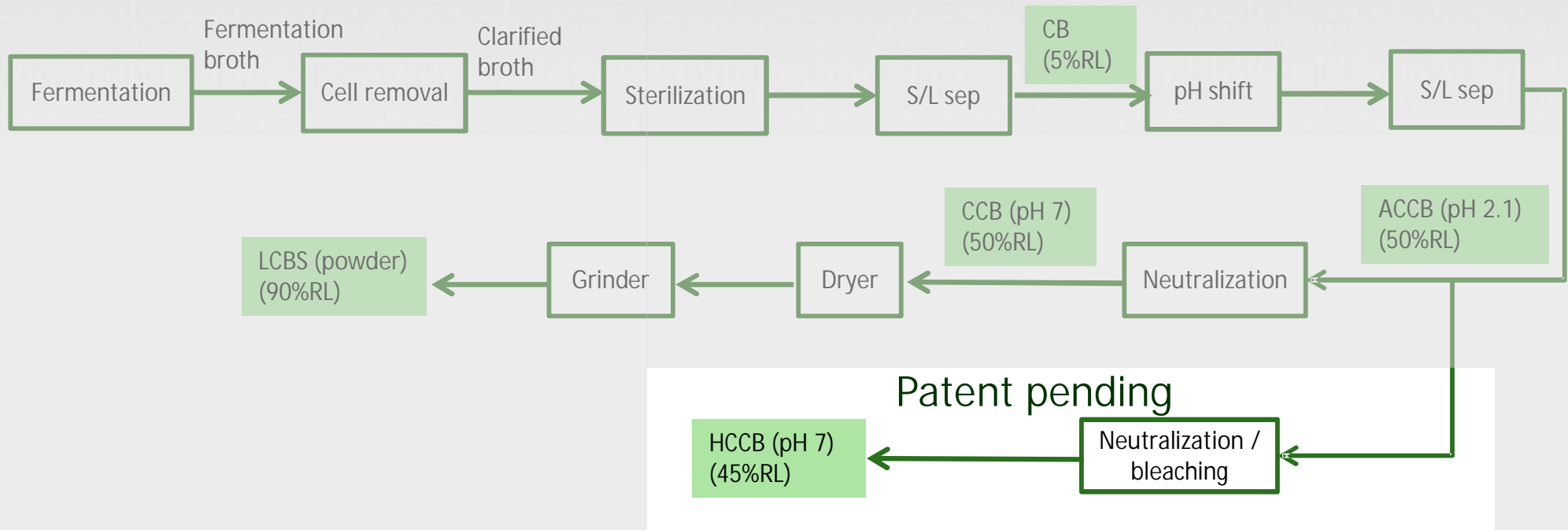

Grade	Description
CB	5% aqueous solution
ACCB	50% water suspension acid form
HCCB	45% aqueous sodium salt form
CCB	50% aqueous sodium salt form
LCBS	90% neat powder sodium salt

	NatSurFact Product Grades		
	HCCB	CCB	LCBS
Form	Solution	Solution	Dry Powder
% Rhamnolipid	45%	50%	90%+
Residual Peroxide	0.5%	NA	NA
Moisture%	51%	47%	5%
Viscosity	3,500 cP	3,500 cP	NA
Preservative	None added	0.4% Benzyl alcohol	None added
Skin Irritation Test	Not a skin irritant		
Eye Irritation	Mild eye irritant		
KeritinoSens (skin sensitization)	Not a skin sensitizer		
Ready Biodegradability (OECD 301 B)	Readily biodegradable		
Activated Sludge Respiration Inhibition Test [carbon and ammonium oxidation] (OECD 209)	Increases efficiency of activated sludge at 1,000 mg/L		
Acute Aquatic Immobilization	> 1,500 mg/L		
Acute Aquatic Toxicity	No toxicity at 100 mg/L		
CMC	100 mg/L		
Draves Wetting Times	20 s @ 5 g/L / 90 s @ 1.25 g/L / 130 s @ 0.25 g/L		

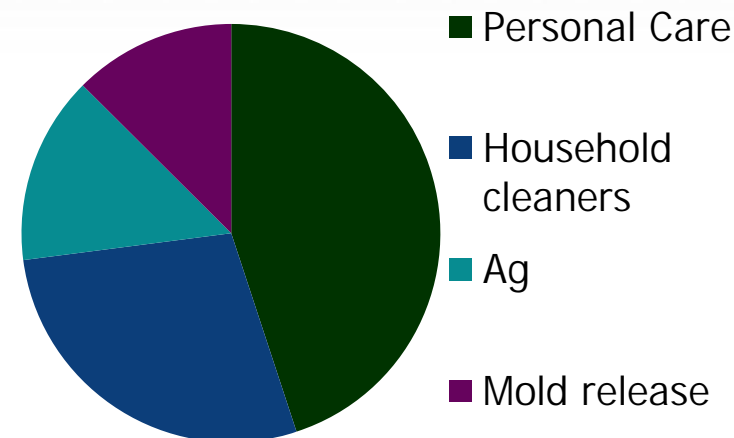

(not all end uses shown)

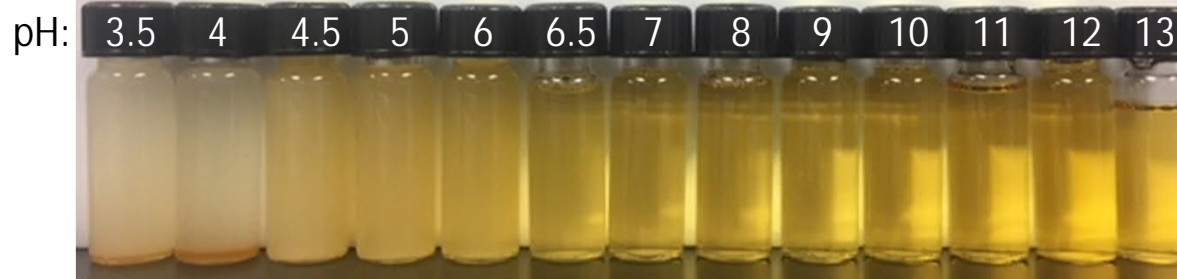

- pK_a estimated at 4.7
- Rhamnolipids are soluble in non-polar solvents in acid form
- Salt form is highly water soluble
- High clarity in water at $pH > 6$

- Candidate for Minimum Viable Product is CCB grade as “Camp Soap”
 - All personal hygiene uses
 - Hard surface (dish) cleaning
 - Contains benzyl alcohol as a preservative







- Cleansers from a formulating artist:
 - 6-15% rhamnolipids
 - Hyaluronic acid
 - Various thickeners and excipients
 - Samples available at in-cosmetics NA



For sensitive skin

Most aggressive ingredient is surfactant.
NatSurFact is extremely mild

Additional Surfactants Markets

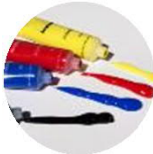
- Household Cleaners
- Industrial & Institutional Cleaners
- Agriculture 
- Food 
- Bioremediation 
- Water Treatment
- Oilfield - including Enhanced Oil Recovery 
- Pharmaceuticals
- Cosmeceuticals 
- Textiles
- Plastics 
- Paints & Coatings 
- Construction

Other Formulations from Customers

- Personal care: Shampoo, Conditioner, Body Wash, Active Beauty / Dermocosmetic
- Others
 - Household and Industrial Cleaners:
 - Spray All-Purpose Cleaner
 - Spray Glass Cleaner
 - Liquid Hand Dish Washing Detergent
 - Liquid Laundry Detergent
 - Liquid Toilet Bowl Freshener
 - Spray Tub and Tile Cleaner
 - Liquid Cleaner for I&I
 - Agriculture: as an adjuvant and for improved nutrient uptake
 - Manufacturing: diverse industries have developed cost saving and green uses





- ✓ Laboratory work
- ✓ Overproducing organism identified
- ✓ Analytical methods developed
- ✓ Trademark created
- ✓ Small samples produced and delivered
- ✓ Product slate created

- ✓ Scale up at tollers and partners
- ✓ Process optimization
- ✓ Patents filed
- ✓ Marketing, conferences and website content
- ✓ Kg quantity samples
- ✓ Regulatory defined



- ✓ Manufacture
- ✓ Multiple applications
- ✓ Patents granted
- ✓ Proprietary formulations developed
- ✓ Downstream process optimization for product grades
- ✓ Consent order granted

Next step in business timeline is manufacturing

kg quantities available for purchase through our website www.natsurfact.com



... TA DA!

[HOME](#) [SHOP](#) [BROCHURE](#) |  

We use innovative, proprietary processes to concentrate NatSurFact so that it is ready to make your products great!

OUR PRODUCTS ARE NOW AVAILABLE FOR ORDER IN BULK QUANTITIES.

WHY NATSURFACT

