

gefördert durch



# HIGH PERFORMANCE VAPOUR PERMEATION WITH ORGANIC MEMBRANES FOR DEWATERING ETHANOL AND OTHER ORGANIC SOLVENTS

ECI Conference Bioenergy - II:  
Fuels and Chemicals from Renewable Resources

Hotel Intercontinental, Rio de Janeiro, Brazil

09.03.2009

**Meik Wusterhausen**

GKSS Research Centre Geesthacht GmbH  
Institute of Polymer Research, Department of Process Engineering  
Max-Planck-Straße 1  
21502 Geesthacht



# HIGH PERFORMANCE VAPOUR PERMEATION

## Overview

- Motivation for dewatering with polymeric membranes
- Engineering package for industrial applications
- Advanced membrane
- Envelope type module
- Simulation result

# HIGH PERFORMANCE VAPOUR PERMEATION

## Motivation for dewatering with polymeric membranes

### Distillation / Vapour Permeation Hybrid Process

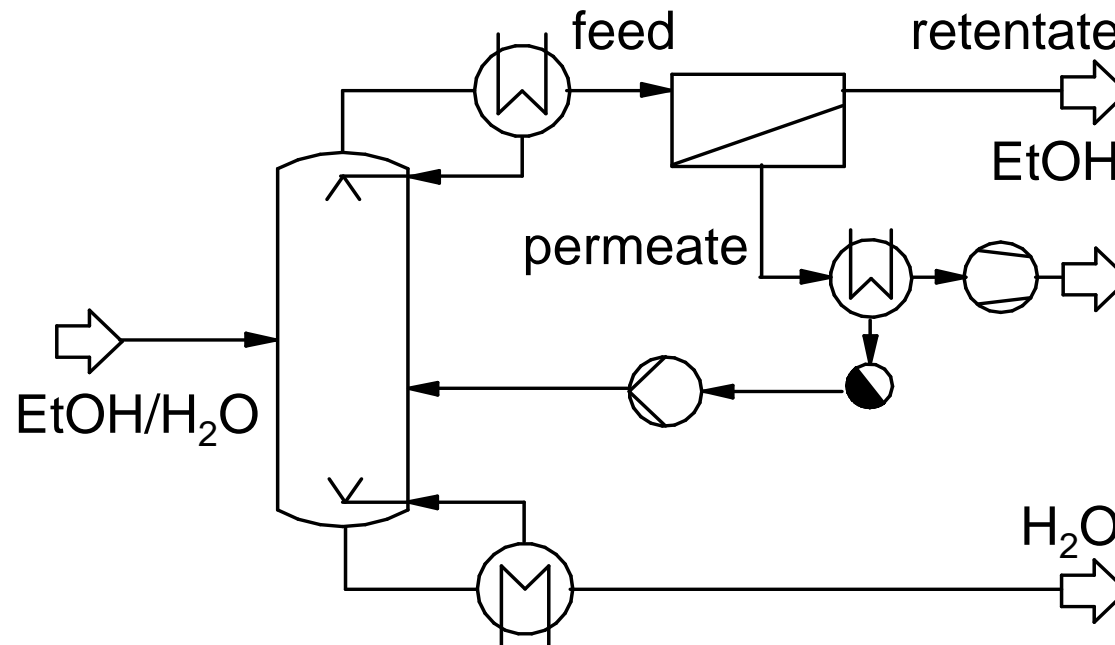

# HIGH PERFORMANCE VAPOUR PERMEATION

## Engineering package for industrial applications

- Membrane receipt
- Coating technique



- Membrane characteristic
- Warranty
- Quality control equipment

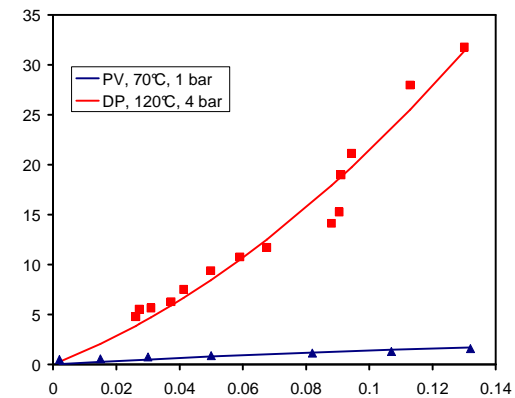

# HIGH PERFORMANCE VAPOUR PERMEATION

## Engineering package for industrial application

- Module design
- Packing and assembling guide



- Simulation software tool
- Support

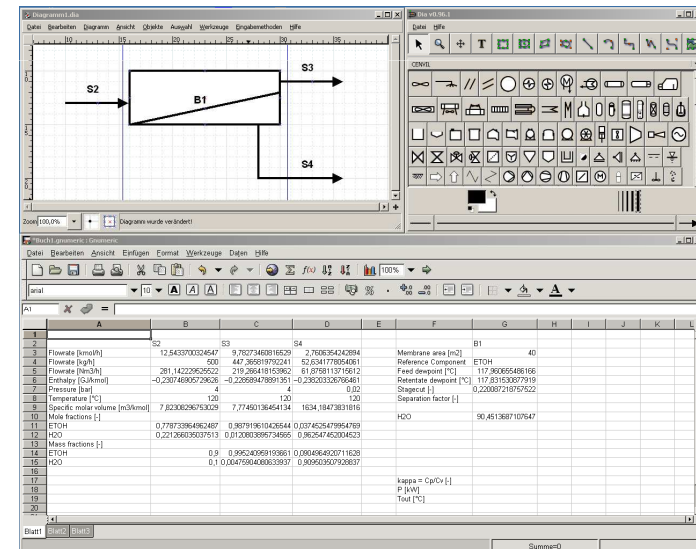

# HIGH PERFORMANCE VAPOUR PERMEATION

## Advanced membrane

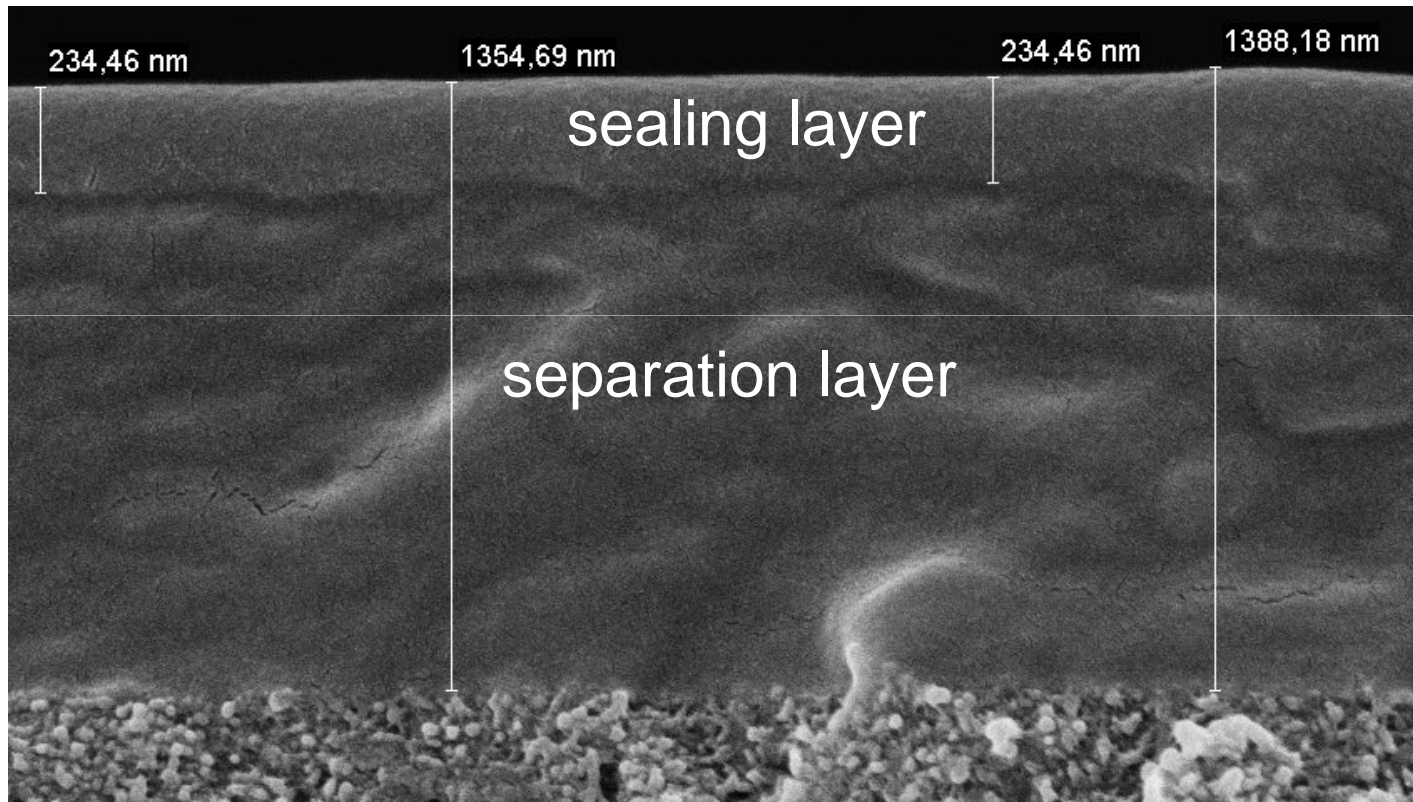

# HIGH PERFORMANCE VAPOUR PERMEATION

## Advanced membrane

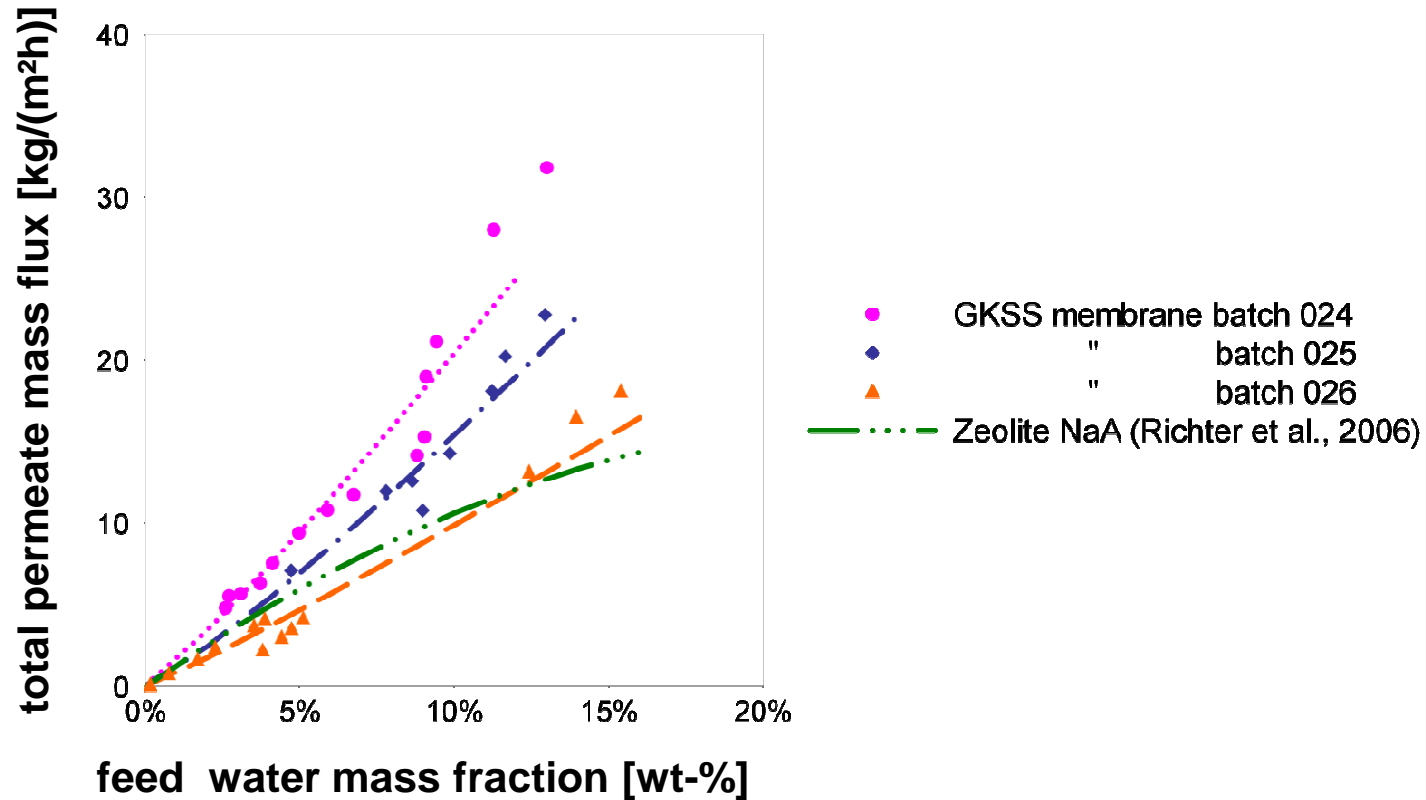

# HIGH PERFORMANCE VAPOUR PERMEATION

## Envelope type module

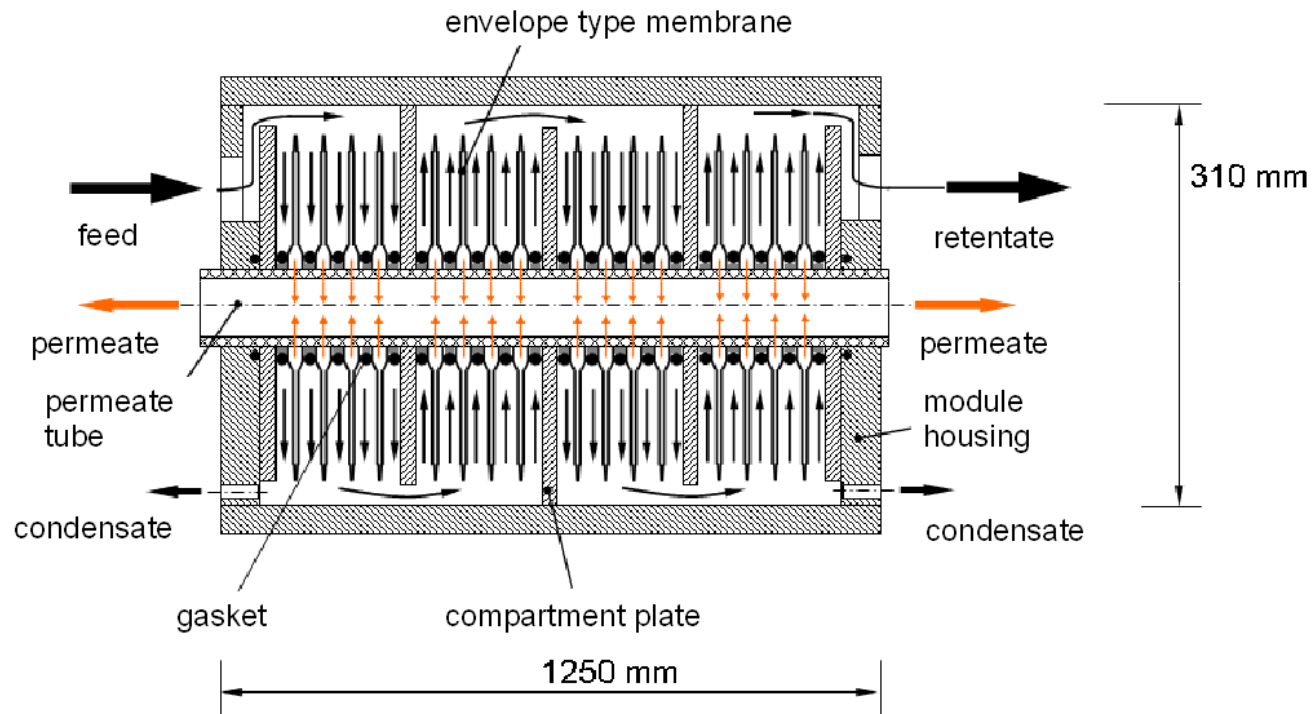



# HIGH PERFORMANCE VAPOUR PERMEATION

## Simulation result

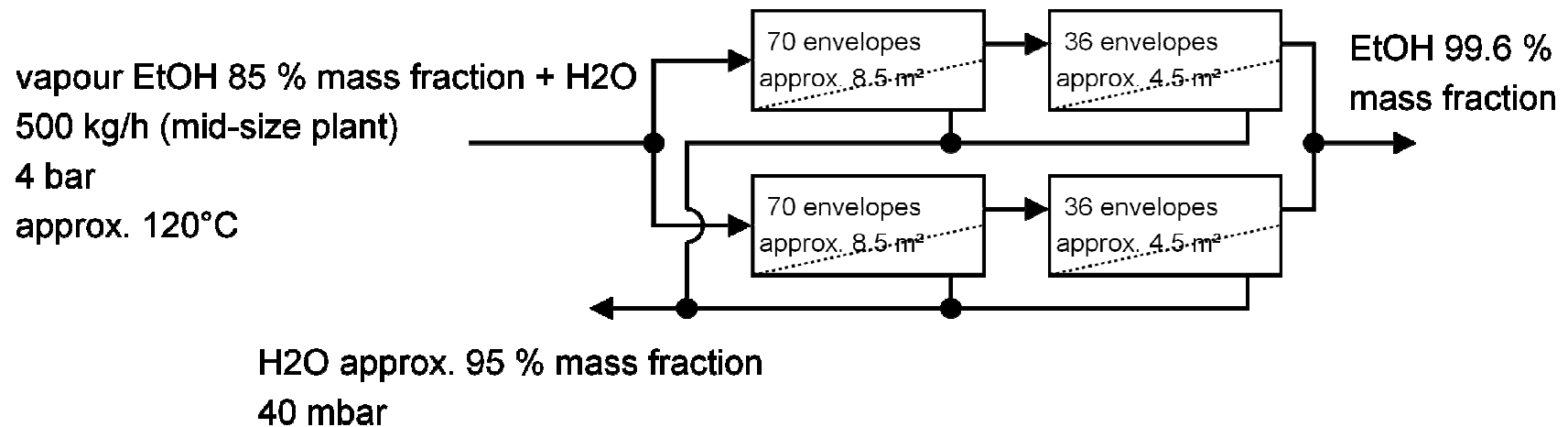

# HIGH PERFORMANCE VAPOUR PERMEATION

## Backup 1: Previous membrane

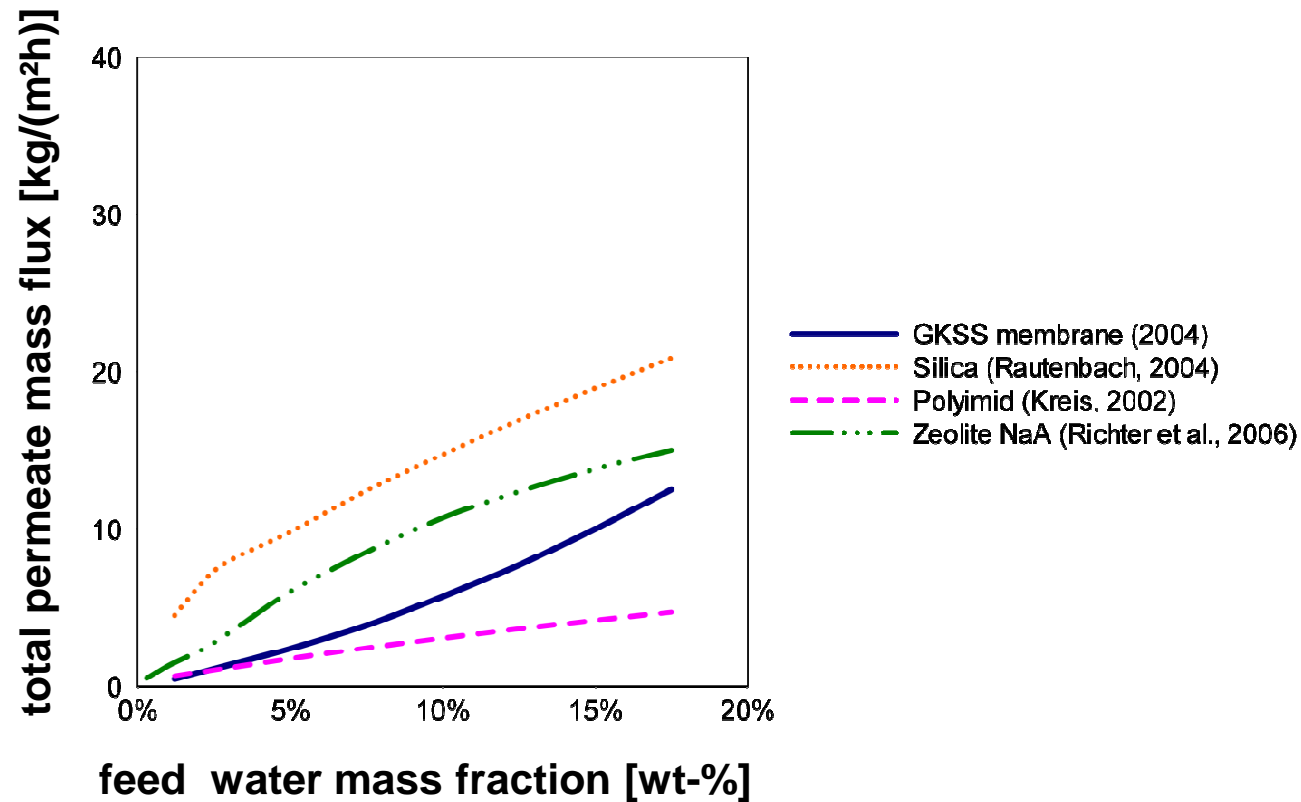

# HIGH PERFORMANCE VAPOUR PERMEATION

## Backup 2: Permeate mass fraction

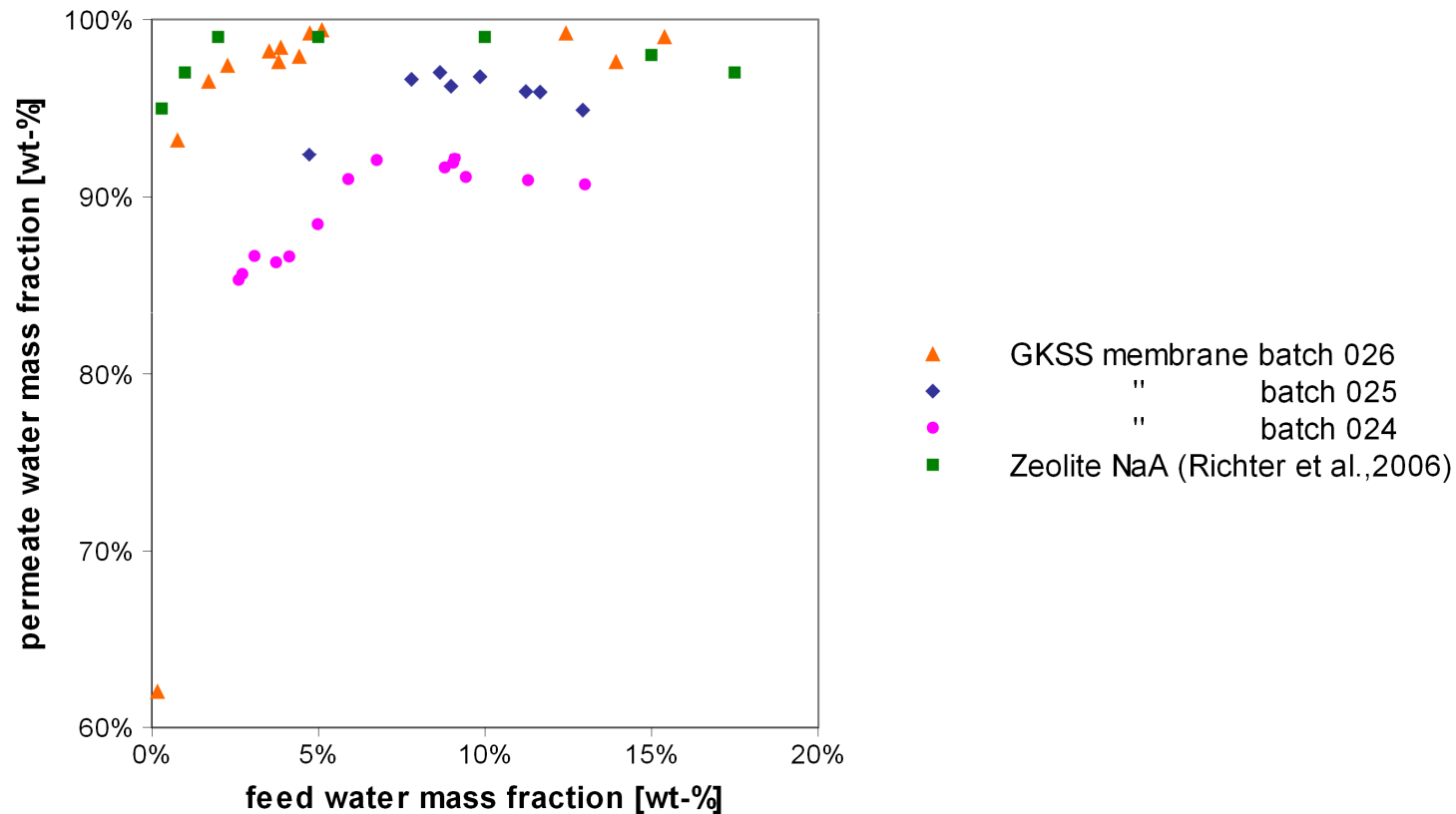

# HIGH PERFORMANCE VAPOUR PERMEATION

## Backup 3: Envelope type module

