

Spring 4-2-2015

Suitability of Geoscan-M elemental analyser for phosphate rock

H. Kurth
Scantech International

Derek Griffiths
Scantech International

Follow this and additional works at: http://dc.engconfintl.org/phosphates_vii



Part of the [Materials Science and Engineering Commons](#)

Recommended Citation

H. Kurth and Derek Griffiths, "Suitability of Geoscan-M elemental analyser for phosphate rock" in "Beneficiation of Phosphates VII", P. Zhang, FIPR; J. Miller, Univ. of Utah; L. Leal, Univ. of Sao Paolo; A. Kossir, OCP Group; E. Wingate, Worley-Parsons Services Pty Ltd. Eds, ECI Symposium Series, (2015). http://dc.engconfintl.org/phosphates_vii/20

This Conference Proceeding is brought to you for free and open access by the Proceedings at ECI Digital Archives. It has been accepted for inclusion in Beneficiation of Phosphates VII by an authorized administrator of ECI Digital Archives. For more information, please contact franco@bepress.com.

Suitability of Geoscan-M elemental analyser for phosphate rock

H. Kurth

Scantech International Pty Ltd.

Presented by: Derek Griffiths

Contents

1. Introduction
2. Geoscan-M using PGNAA
3. Applications and Benefits in Phosphate
4. Examples of performance
5. Summary

1. Introduction

- * Real time, continuous, through belt, multi-elemental analysis of conveyed flows enables operators to measure & control feed & product quality
- * Advanced technology is proven
- * Applications – monitoring, bulk sorting, blending
- * Benefits and paybacks

2. Geoscan-M using PGNAA

Prompt Gamma Neutron Activation analysis

- * Cf-252 source (under conveyor belt) emits neutrons
 - * Neutrons absorbed by elements in conveyed material
 - * Each element emits a unique gamma ray spectrum
 - * BGO detector array (over conveyor) measures gamma rays
-
- * Operating 10+ years in minerals sector (>50+ installations, incl. P)
 - * Combined with microwave moisture measurement
 - * Multi-elemental results reported every 2 – 5 minutes

Geoscan-M using PGNAA

How Geoscan Works

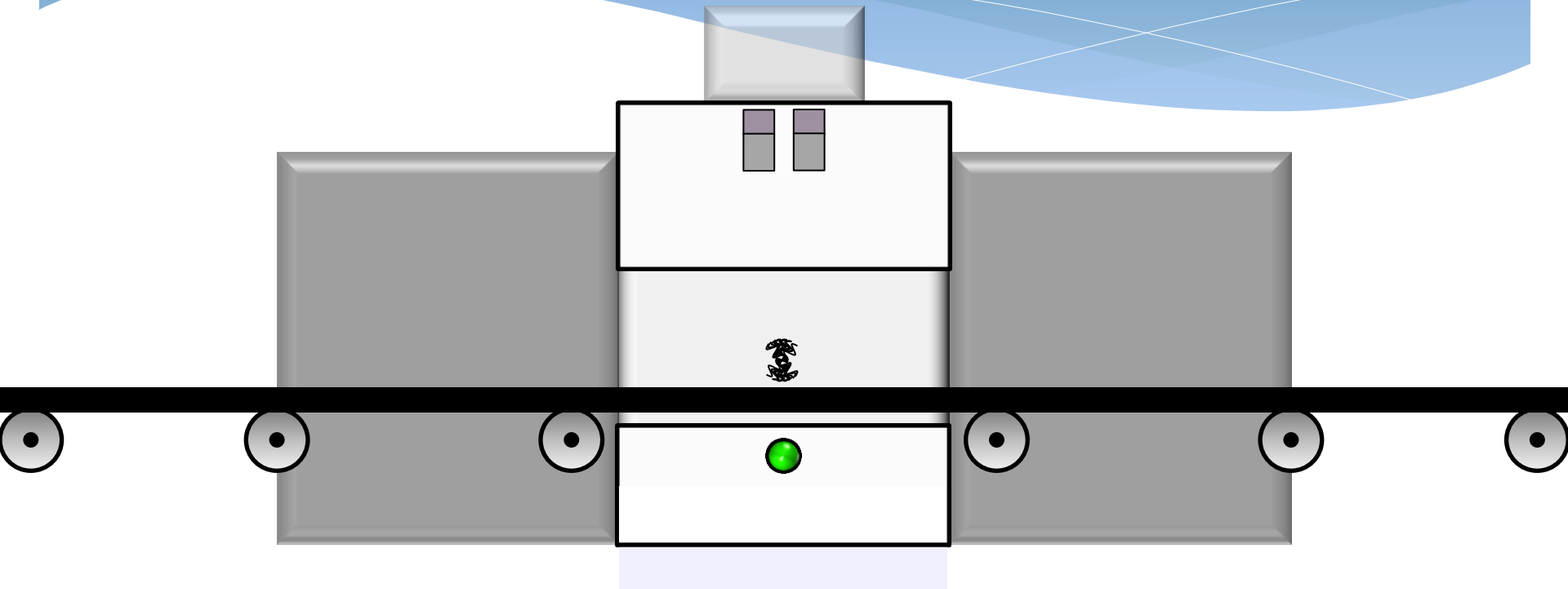

SiO_2 %	Al_2O_3 %	Fe %	TiO_2 %	K_2O %	Mn %
8.88	1.88	68.88	0.08	0.28	0.08

Geoscan-M using PGNAA

- * Fully transmissive
- * Continuous
- * Non-contact
- * Mineralogy, particle size, dust, moisture no effect
- * Belt scale input for tonnage weighted results
- * Moisture measured (TBM)
- * **Safe – can stand next to operating unit**

Typical analysis spectrum

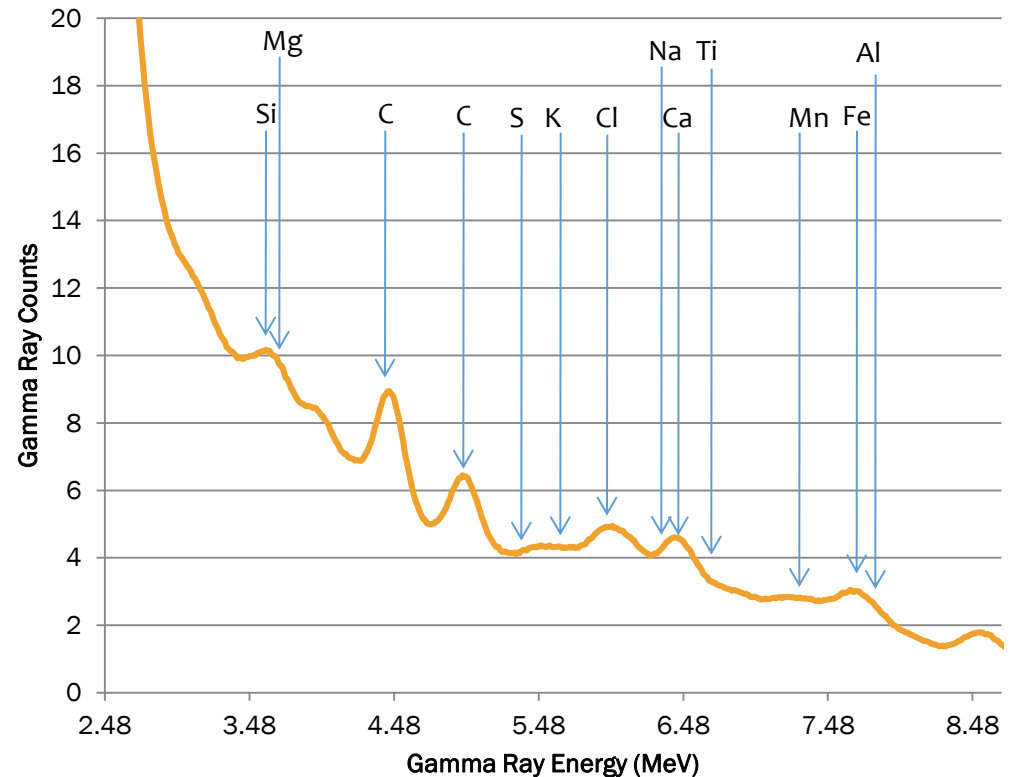

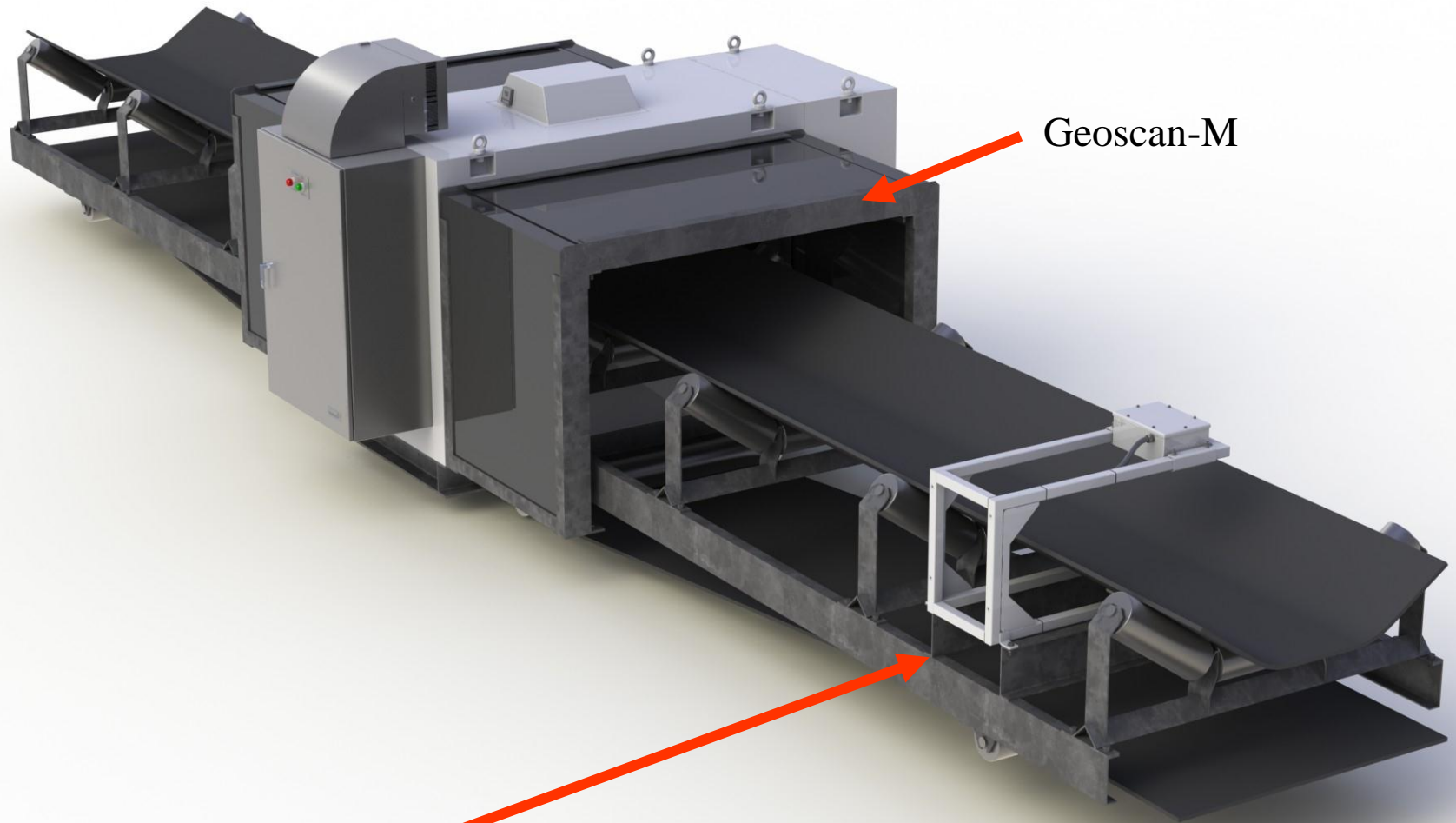

Geoscan-M

TBM Moisture Monitor

PGNAA vs XRF, LIBS, NMR

PGNAA

Measures full cross section continuously

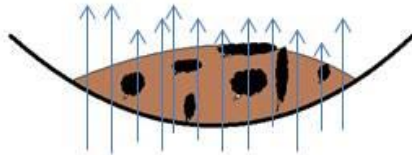

- Penetration : 0.5m+
- Tonnage limited only by belt size & depth (approx 17kt/hr), min 20kg/m belt load
- No matrix effects, measures elements
- Unaffected by layering, particle size, belt speed, dust
- Representative for all profiles & mixtures
- Low maintenance

XRF/LIBS

Measures surface spots every few metres

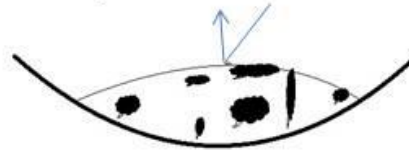

- Penetration: sub-mm
- Measures spots only
- Very large sampling error
- Matrix effects: Ca, Fe.
- Layering gives biased analysis
- Dust is a problem
- ONLY representative if material is 100% homogeneous, unlikely
- High cost for amount measured
- High maintenance

NMR

Analysers a small sample periodically



- Very small sample
- Large sampling error
- Sampling system essential
- Off line measurement
- ONLY representative if material is 100% homogeneous, unlikely
- Very high cost for amount measured
- High maintenance

3. Applications and Benefits in Phosphate

- * Measure beneficiation feed quality for plant control
- * Sort phosphate rock onto stockpiles, remove waste
- * Blend to improve quality consistency
- * Blend into acid reactor feed
- * Control sulphuric acid addition to acid reactor based on feed rock chemistry to maximise P_2O_5 recovery & Ca to gypsum

4. Examples of performance

North African sedimentary phosphate rock

Elements	Min	Max	Expected Precision
P ₂ O ₅	17	45	0.42
MgO	0.5	6	0.44
SiO ₂	0.5	17	0.35
CaO	43	52	0.38

Examples of performance

North American sedimentary phosphate rock

Elements	Min	Max	Expected Precision
P ₂ O ₅	20	35	0.71
Al ₂ O ₃	0.5	2	0.25
Fe ₂ O ₃	0.5	2	0.09
CaO	40	50	0.38
MgO	0.2	1	0.15
SiO ₂	2	10	0.28

Examples of performance

Middle Eastern
sedimentary
phosphate rock

Elements	Min	Max	Expected Precision
P ₂ O ₅	17	25	0.42
MgO	0.5	6	0.44
SiO ₂	0.2	10	0.35
CaO	43	52	0.38

Conclusion

- * *“The Geoscan-M has shown excellent results on the phosphate ore as expected from Scantech products.*
- * *Scantech welcomes site to provide their laboratory report for these ore samples so that the Geoscan-M results can be regenerated and optimised with respect to site laboratory results.*
- * *The results demonstrate that the Geoscan-M is suitable for quality control at this site”.*

Examples of performance

Russian
igneous
phosphate
ore

Elements	Min	Max	Expected Precision
P ₂ O ₅	3	10	0.38
SiO ₂	6	11	0.66
Al ₂ O ₃	1	3	0.45
Fe	15	35	0.80
CaO	14	24	0.95
MgO	11	14	0.60
S	0	1	0.10
TiO ₂	0	1	0.08

Examples by element

%P₂O₅ in Phosphate Rock (-6mm screening)

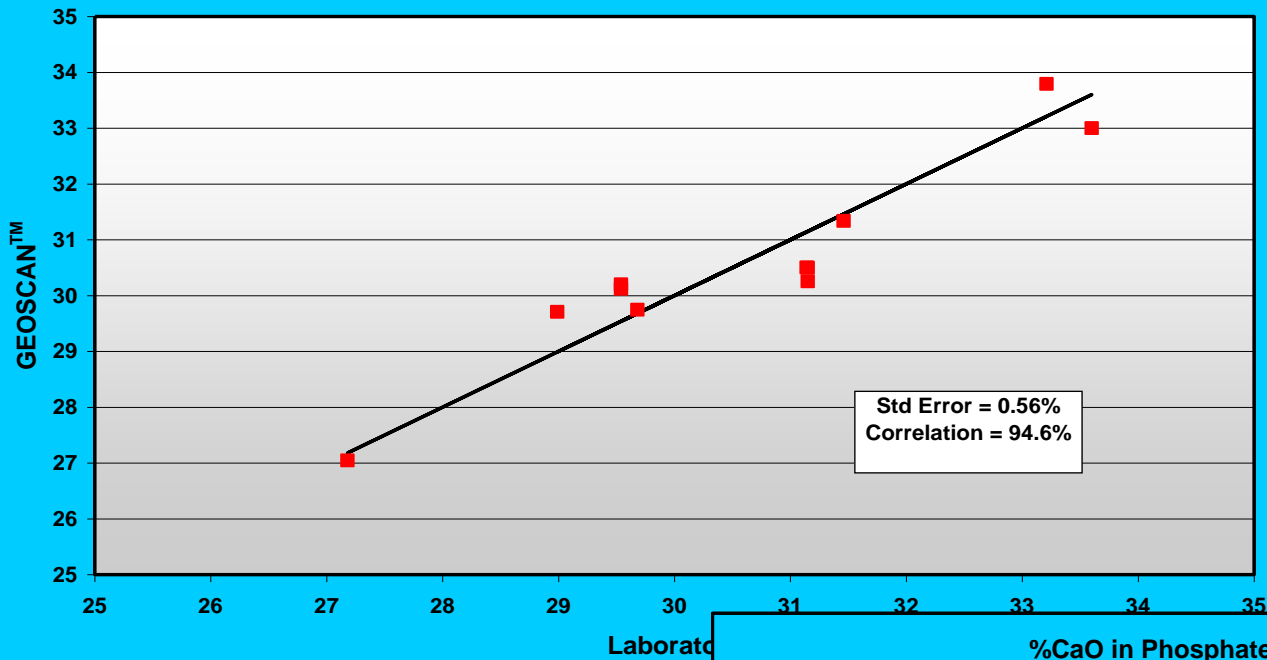

%CaO in Phosphate Rock (-6mm screening)

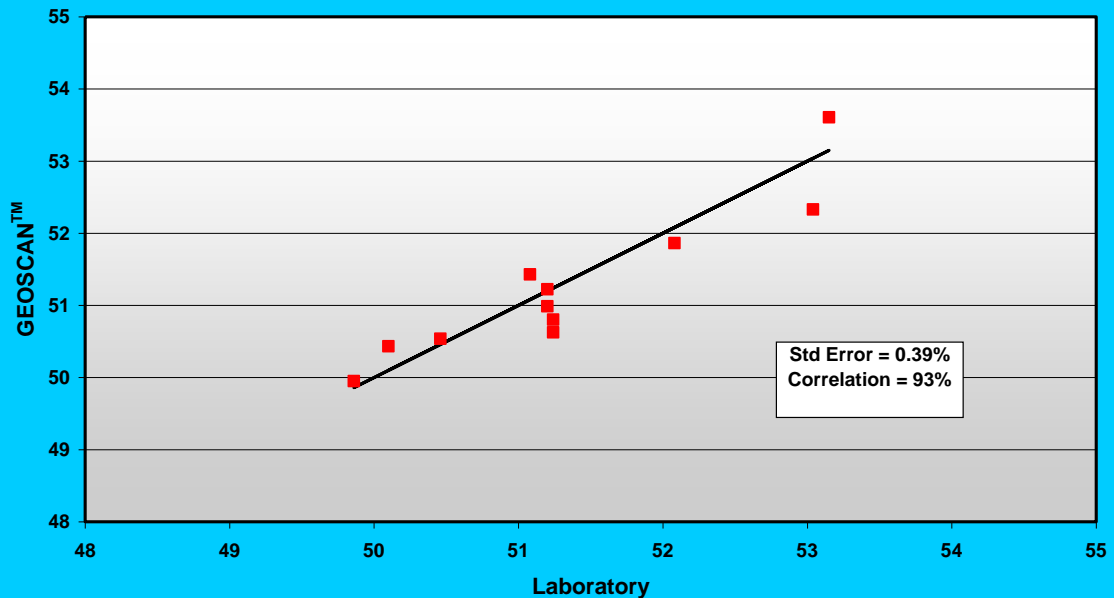

Examples by element

%SiO₂ in Phosphate Rock (-6mm screening)

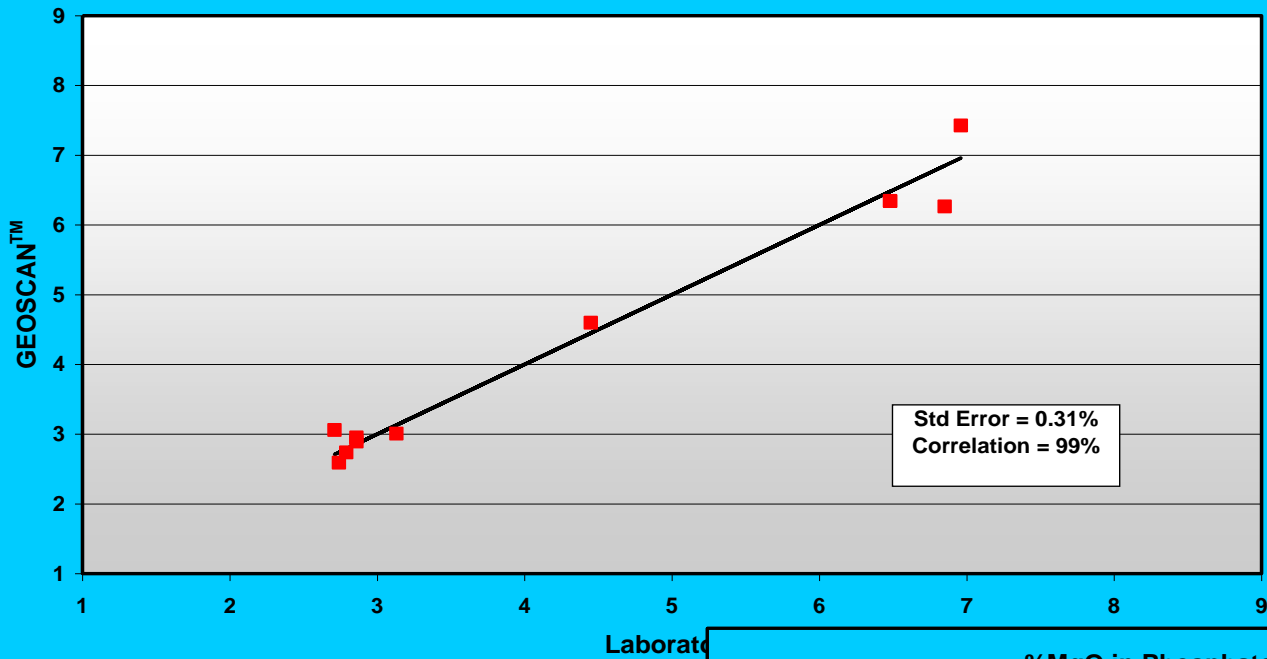

%MgO in Phosphate Rock (-6mm screening)

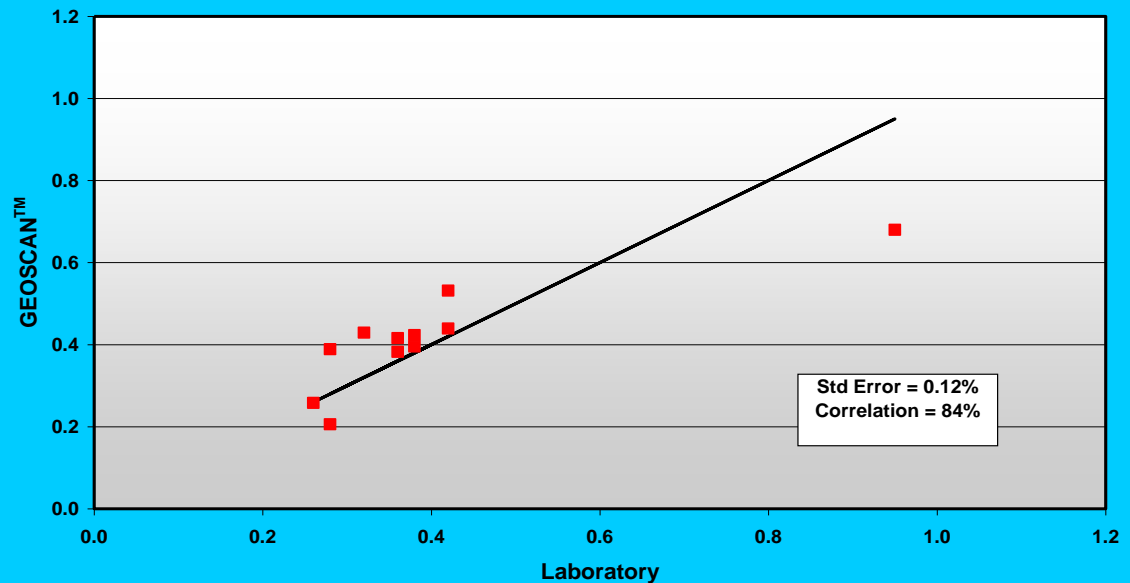

Examples of performance

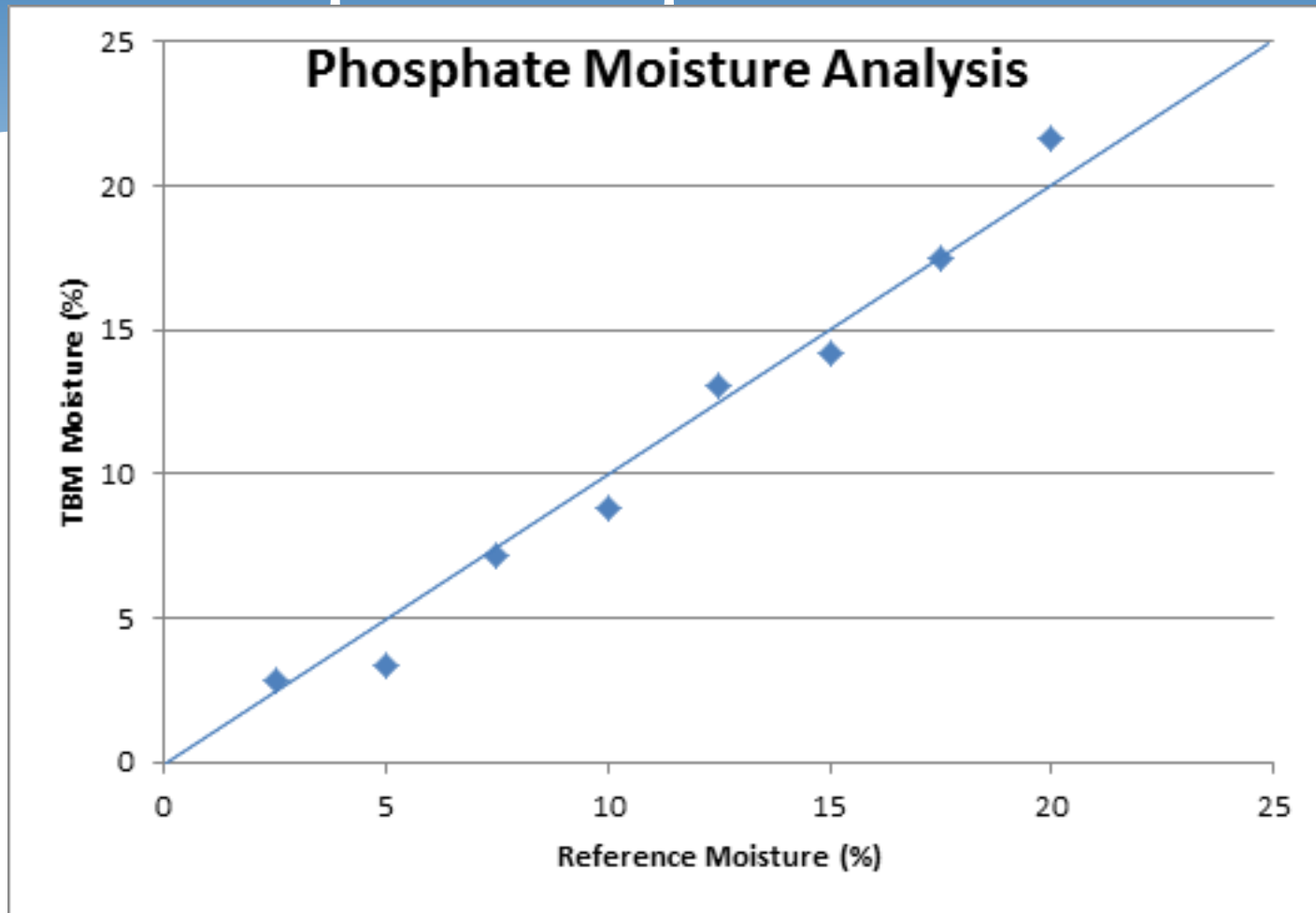

Examples of performance

- Analysers installed in North America & North Africa
- Applications: phosphate rock feed to beneficiation for ore blending, bulk sorting to stockpiles & acid reactor feed
- Performance guarantees (elements) reduce customer risk
- Pay back <6 months on acid digest application
- YR1 technical support included to optimise performance, service engineers located in key regions

Examples of performance - compelling evidence of benefits

- * On-line spectrometry has been one particularly fruitful technology that has helped the US phosphate industry to innovate, cut costs, improve efficiency and reduce environmental impact.
- * “FIPR has also long championed the potential for on-line chemical analysis for improving the performance of phosphate beneficiation plants.”
- * A US fertilizer company uses “analysers for quality control purposes at one of their beneficiation plants and is saving several million dollars annually as a result.”
- * quotes from **Patrick Zhang**, beneficiation and mining research director, FIPR, in Fertilizer International 465: March-April 2015 issue.

4. Summary

- * Technology is proven - safe, reliable, accurate
- * Representative system measures real time on-belt
- * Remove waste increments from feed
- * Bulk sort & blend phosphate rock → consistent feed
- * Improve process control & efficiency – proven benefits
- * Reduces operating costs, short payback (<6 months)
- * Maximise P₂O₅ recovery, acid consumption & Ca removal

Further information:

www.scantech.com.au

h.kurth@scantech.com.au